



# Computational Neuroscience

Angus Chadwick

School of Informatics, University of Edinburgh, UK

Computational Neuroscience (Lecture 1, 2024/2025)

# Outline of Lecture

---

- Course outline and formalities
- Motivation and introduction to computational neuroscience
- Q and A

# Welcome to CNS

---

- **Goal of CNS:** Understand how the brain works, including biophysics of neurons, how the nervous system processes information and performs computations, how these computations generate perception, cognition and behaviour
- **Highly interdisciplinary field:** Combines ideas from computer science, maths, physics, biology, psychology, artificial intelligence, machine learning, etc.
- **Learning outcomes:** understand computational models of brain function, think critically about how to model aspects of brain function, implement models in code and analyse them mathematically

# Is CNS for You?

---

- CNS is a course about the brain and computation in the nervous system
- We make *extensive* use of mathematics and computational/numerical techniques to build and interpret models of brain function
- CNS is **not** a course that is widely useful for industry or applications (such as AI/ML)
- Problems in CNS are often open-ended with no correct answer, the biology is messy, the brain is too complex to modelled exactly – you need to be comfortable with vagueness and uncertainty, and willing to do some independent reading!
- Computational neuroscience is an extremely interesting and exciting field!

# Relationship to Other Courses

---

- **Computational Cognitive Neuroscience** (CCN: Semester 2) – stronger focus on cognition and on the field of computational psychiatry. Some overlap, but CNS is good preparation for CCN.
- **Computational Cognitive Science** (CCS: UG3 Semester 1) – less focus on biology/brain, more cognitive and algorithmic

Previous/extinct courses:

- **Neural Computation** (NC) focused on biophysical models of neurons
- **Neural Information Processing** (NIP) focused on AI-inspired theories of brain function
- **Computational Neuroscience of Vision** (CNV) focused exclusively on the visual system
- CNS covers elements of both NC and NIP, but often in less depth. We will also cover some visual neuroscience.

# Requirements for this Course - Maths

---

- **You need to know:** calculus, linear algebra, probability theory, differential equations
- Not very advanced but used extensively. Solving equations and performing analytical derivations is required for the labs, assignment, and exam
- Examples: linear first order ODE, Poisson process, matrix/vector algebra, Taylor expansion, limits of functions for small or large arguments, Dirac delta function
- Mathematics is the primary tool we use to study the brain in this course - if you do not enjoy studying model systems mathematically in order to gain insight into their behaviour, you will not enjoy this course!

# Requirements for this Course - Coding

---

- **Coding:** Numerical computing, to implement models and investigate their properties
- The computer labs assume Python, but you are free to use another language if you prefer (e.g., Julia, Matlab)
- You will need to solve differential equations numerically, plot the results, etc.
- Coding is never the end goal/learning outcome in this course, it is used only as a tool to study models of the brain. Correctness of code is required but the primary goal is to critically interpret your findings in the context of biology. Code is never assessed.

# Requirements for this Course - Biology

---

- We will cover a lot of biology in this course, be prepared!
- No formal knowledge of neurobiology is required (but much to be learned)
- Some background reading is highly recommended (see Learn for basic resources)
- We aim to provide the bare minimum of biology needed to understand the key concepts, but there is a whole world of messy biological details out there!

# Requirements for this Course - Physics

---

- Many models in computational neuroscience involve tools/knowledge of physics
- We will cover some basic physics concepts (capacitance, conductance, voltage, etc.)
- No prerequisites, we will introduce concepts as they come up
- The physics concepts we cover are roughly at mid high school level

# Assessment

---

- 25% assessed coursework, 75% exam
- 1x assignment (25%). Implement a model in Python. Simulate, critically evaluate, and discuss your findings. May also involve some mathematical analysis. Some questions may be open-ended and might not have a single definitive answer.
- **Deadlines:**
  - Assignment 1 (due November 22<sup>nd</sup>) [25%]
  - Exam (date tbd) [75%]

# Lectures

---

- Lectures delivered **in person** – recordings available on Learn, slides etc. on <https://opencourse.inf.ed.ac.uk/cns/schedule>
- Lecture times: 3.10pm Tuesday and Friday in 40 George Square (LG.11)
- Please interrupt and ask questions during lectures, especially if something was unclear or too fast. Interactions are encouraged!

# Computer Labs

---

- Labs every two weeks (Week 1, 3, 5, 7, 9, 11). 2 hours each, in Appleton Tower 6.06
- Two labs: Thursday 2.10pm, Friday 1.10pm. Labs are “Drop-In” (i.e. you can attend either of them)
- Format of labs: 1) coding and implementation of models in Python 2) some tutorial/exam style questions

Labs are good practice for the assignment! The TAs will also provide additional derivations/extensions of material covered in lectures

- Lab this week: learn to solve differential equations in Python. Please attend!

# Office Hours, Discussion, etc.

---

- **Office Hour:** catch me after lectures or talk to one of the TAs in a computer lab
- **On Piazza:** Post questions/discussion about the course. Will be monitored by lecturer and TAs. Peer interactions also encouraged.

# Course Contacts

---

- First point of contact should always be Piazza! Post a private question if it is confidential, you should only email the lecturer in exceptional circumstances (e.g., can't gain access to Piazza)
- **Lecturer/Course Organiser:** Angus Chadwick ([angus.chadwick@ed.ac.uk](mailto:angus.chadwick@ed.ac.uk))
- **TAs:** Hongkun Wu and Arthur Pellegrino
- **Markers:** Hongkun Wu and Arthur Pellegrino

# What is Computational Neuroscience?

*“Computational neuroscience is the field of study in which mathematical tools and theories are used to investigate brain function. It can also incorporate diverse approaches from electrical engineering, computer science and physics in order to understand how the nervous system processes information.”*

Nature (academic journal)

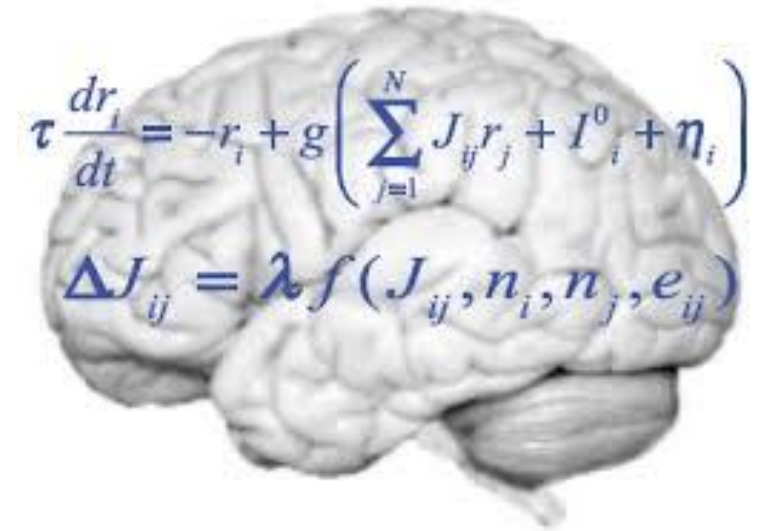

# What is Science? [Philosophical Interlude]

- Broadly speaking, scientists attempt to **explain** things about the world using **theories**
- Theories are usually a set of **equations**, and the behaviour of the equations is compared to **experimental measurements** of the system in question
- A good theory should have explanatory power: it should **generalise** across situations, it should explain disparate observations in terms of a smaller set of **underlying principles**, and it should provide **conceptual insight** (“understanding”)
- Theories are always **approximations/abstractions** - they have a domain of application and break down when assumptions are violated
- In most cases, scientists proceed by breaking a problem down into simpler manageable subproblems, solving those, and hoping that that these simpler problems give insight into the real world (i.e., **reductionism**)

# Why is Understanding the Brain Hard?

- The brain is a highly **complex system**, with collective and **emergent behaviour**
- Breaking the brain down into parts is possible (e.g., we can study neurons), but **the whole is more than the sum of its parts** (networks of neurons behave differently to isolated neurons) – **reductionism doesn't work!**
- We can simulate complex models of the brain, but **simulations don't give understanding** (e.g., why did this simulation behave this way, how does the qualitative behaviour depend on the parameters?)

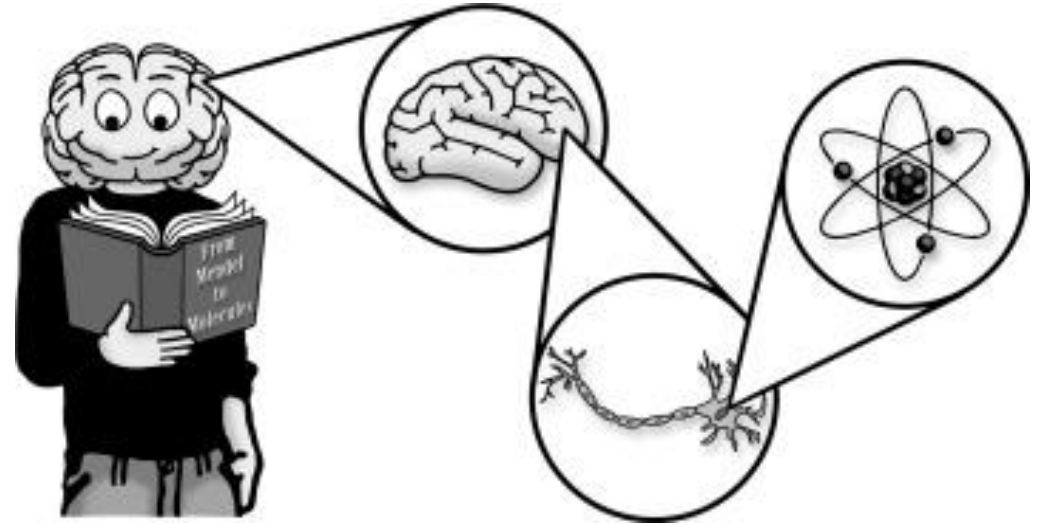

# What Do(n't) We Know About the Brain?

---

- We have collected **many facts** about the brain, but have **no coherent understanding** of how it works
- We also **don't know how to find out how the brain works...** (e.g., if we can't even understand a deep network, how can we hope to understand the brain?)
- In this course you will learn many interesting facts about the brain, but the deepest and most interesting questions will remain unanswered

# The Scales of Neurobiology

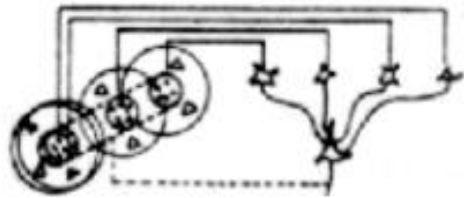
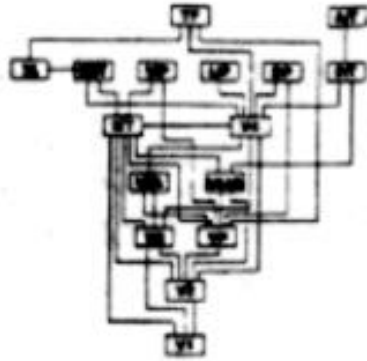
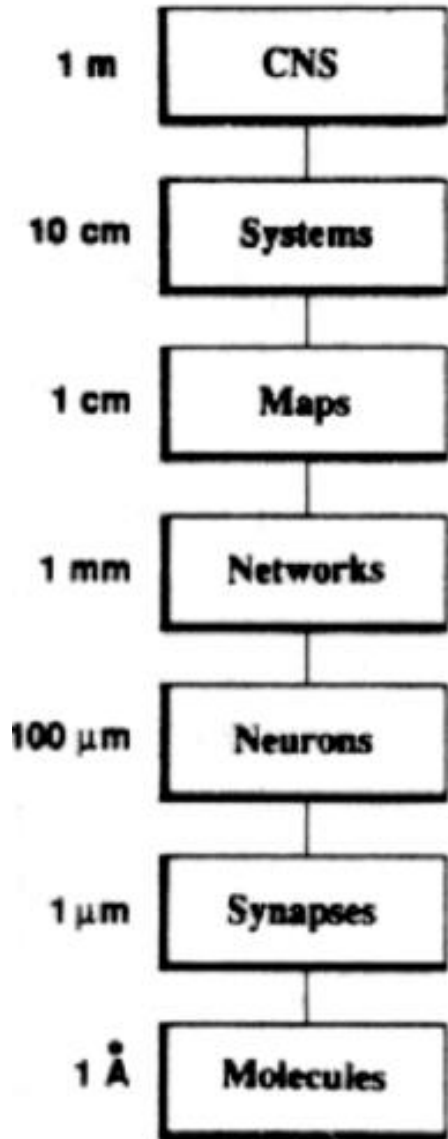

The brain is a complex system spanning multiple spatial and temporal scales (molecular to behavioural, milliseconds to years)

To understand the brain, we need:

- models/theories that address each scale
- organising principles which span these scales
- theories of various kinds (what, why, how?)

Our understanding of the brain is still rudimentary

# Questions of Computational Neuroscience

---

## Computational neuroscience:

Emphasises understanding how *computations* are performed in the brain. Cognition and behaviour are the result of such computations

## Central question:

How does the brain work? How are perception, learning, memory, decision making, language, etc. generated by the concerted action of billions of neurons?

# Tools of Computational Neuroscience

---

**Computational Neuroscience:** uses computational/mathematical tools to understand the brain, by developing:

- Theories about the brain (using maths)
- Computer simulations (“in silico” experiments)
- Data analysis methods (e.g., machine learning)

Try to answer:

**What?** Descriptive/phenomenological/statistical explanation

**Why?** “Teleological”/functional/normative explanation (in terms of *optimality*, i.e. evolution)

**How?** “Mechanistic” explanation, i.e. *causal* or *physical* explanation in terms of biology

# The Data of Neuroscience

---

**Human and animal studies:** primates, cats, rodents, birds, insects, etc.

**Measurements of behaviour:** e.g., psychophysics, memory, linguistic tasks

**Measurements of neural activity:** e.g., EEG, fMRI, intracellular recordings, many more...

**Perturbations** of neural activity or behaviour: e.g., pharmacological, electrical, optical

**Lesion studies:** e.g., accidental injuries (gunshot wounds, WW1), result of brain disease, result of corrective surgery (e.g., split brain patients)

**Case studies:** neurological disorders (blindsight, hemispatial neglect, face blindness...)

# Measuring Behaviour/Perception

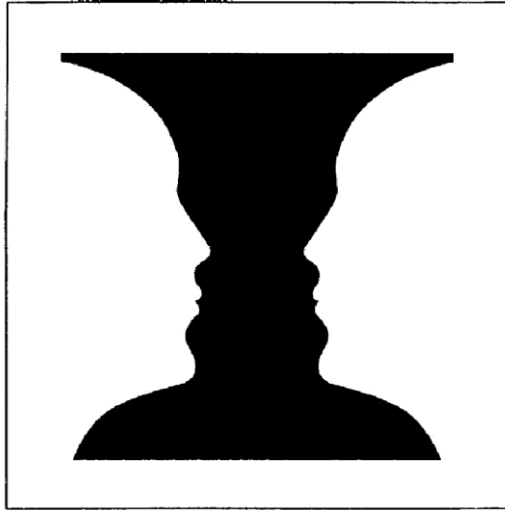
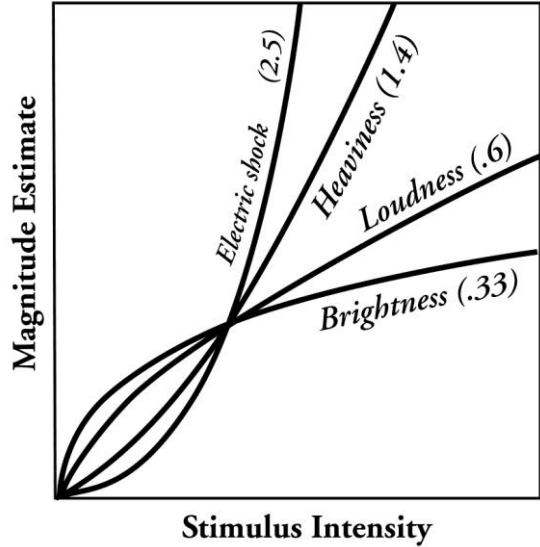

## Human Psychophysics:

*Behavioural report of perception*

*Left: How intense? (Fechner's law)*

*Middle: Faces or vase?*

*Right: Gustav Fechner*

**B**

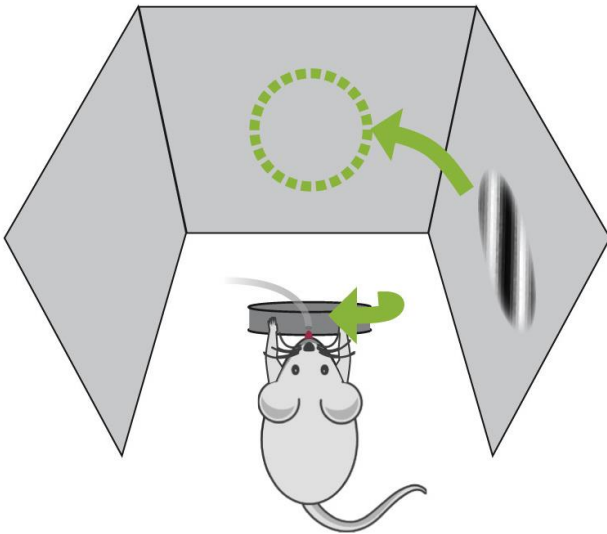

**C**

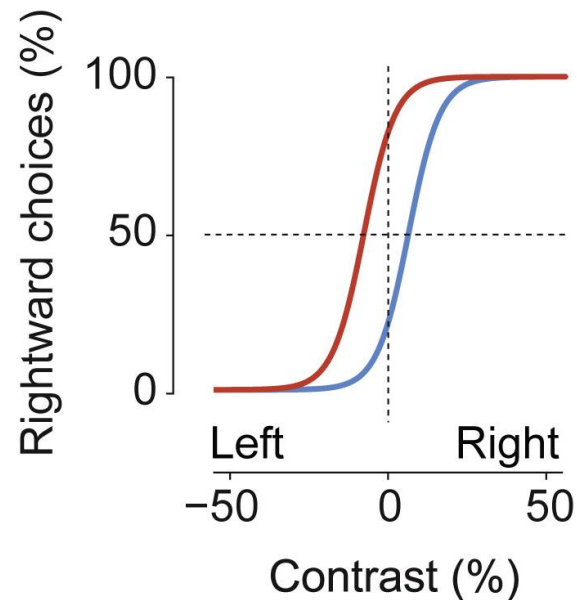

## Animal Psychophysics:

*Left: Mouse behavioural task*

*Right: Measured Psychophysical curves*

# Measuring Neural Activity – Non-invasive Imaging

Electroencephalogram (EEG)

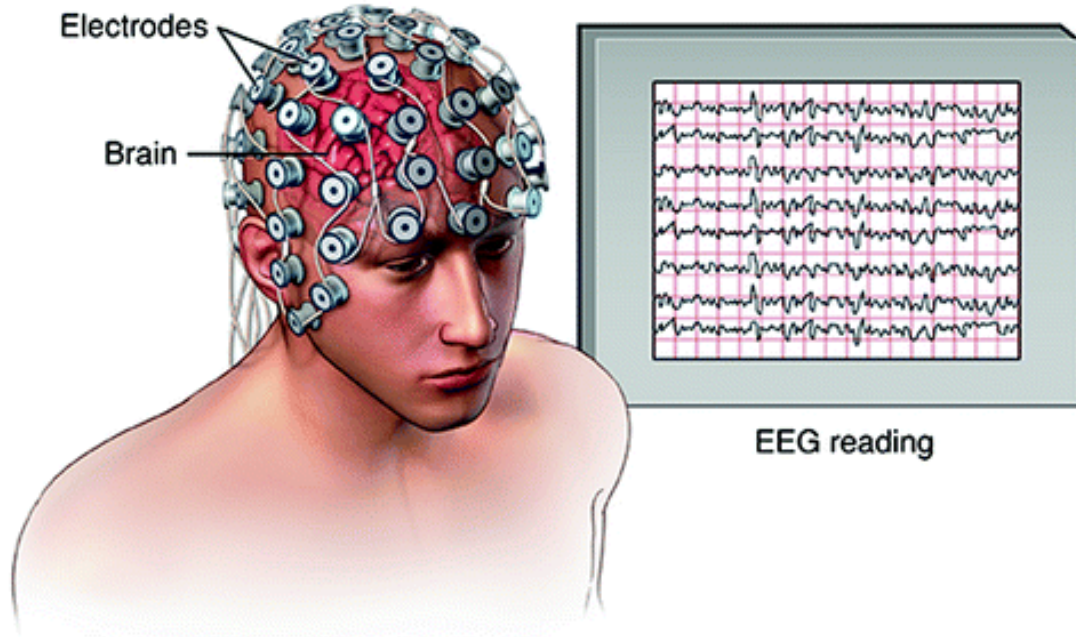

EEG – high temporal but low spatial resolution. Noisy, contaminated, indirect measurement of brain's electrical field.

fMRI

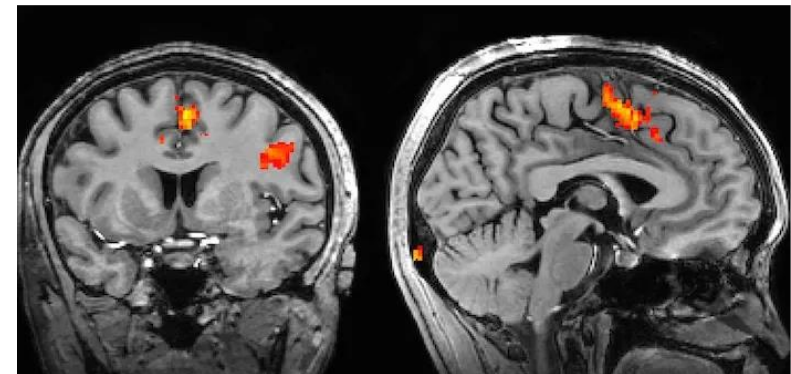

Low temporal but high spatial resolution. Measures BOLD signal (blood flow)

# Measuring Neural Activity – Invasive Electrodes

**Electrodes:** intracellular or extracellular.

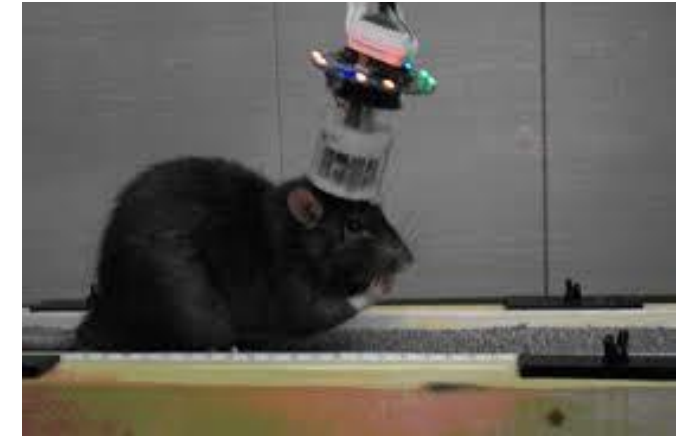
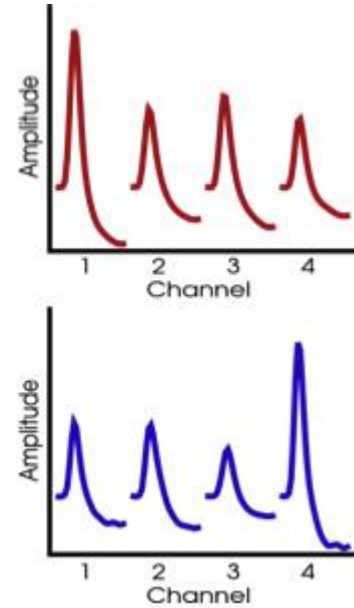
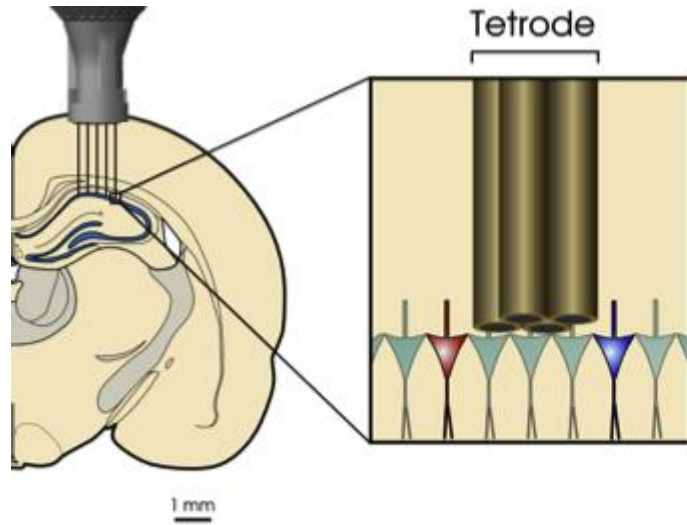

**Pros:** measure from single neurons at high temporal resolution, measure electrical activity

**Cons:** Invasive, limited to working with animals, can't record from many cells simultaneously, data pre-processing tricky

# Measuring Neural Activity – Invasive Imaging

## Two-photon calcium imaging

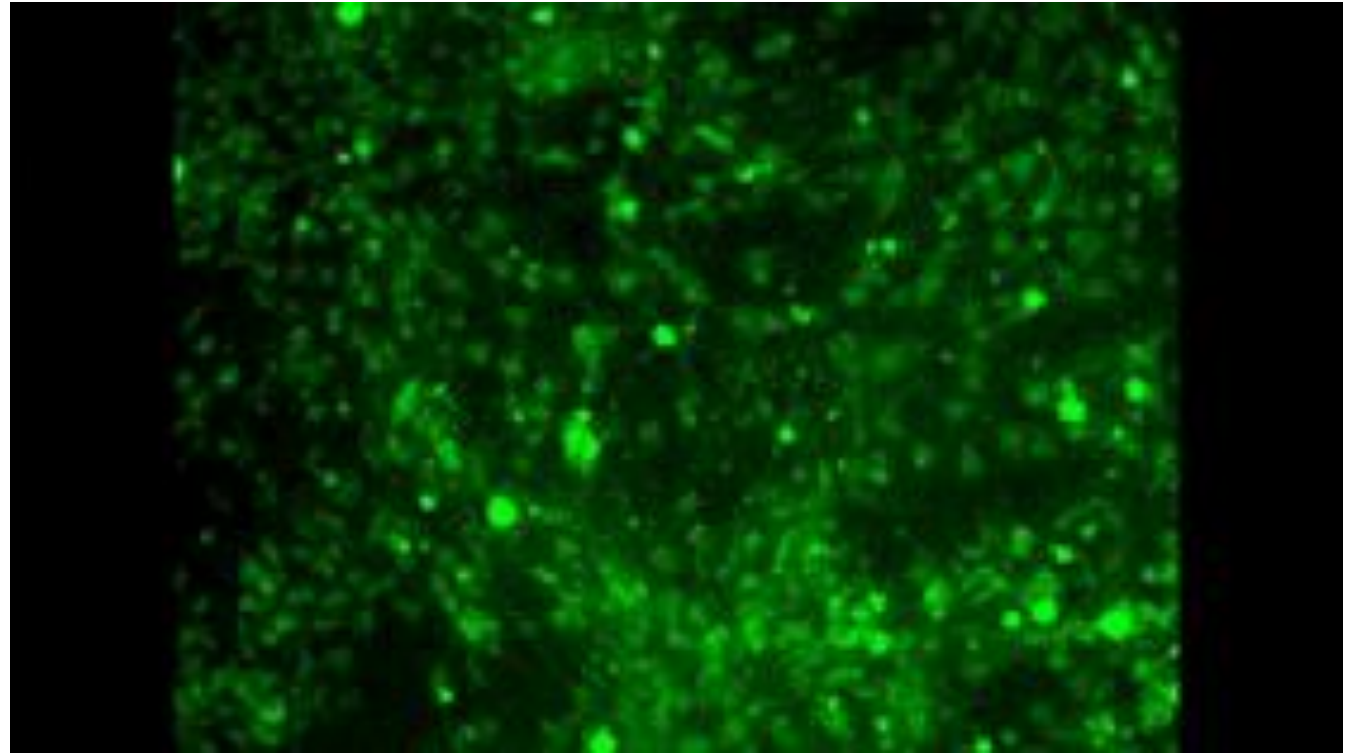
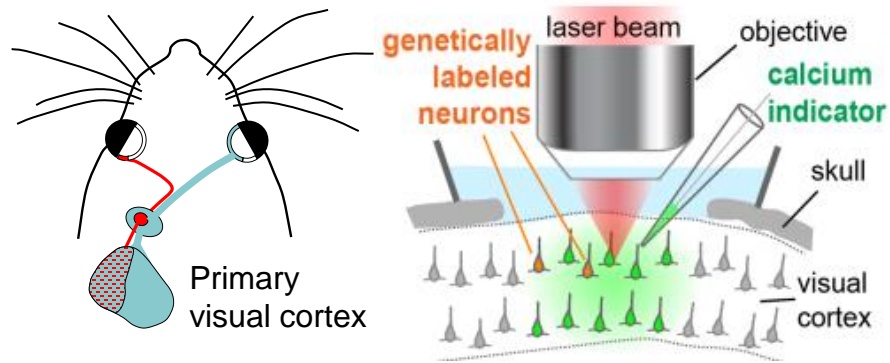

**Pros:** Image many cells at once, high spatial resolution

**Cons:** Invasive, measure only calcium fluorescence, low temporal resolution, data pre-processing tricky

# Textbooks

- Much of the lecture material is adapted from these books – these are available on course Resource List. Use these to supplement the lecture material
- We also have detailed lecture notes from a previous course (Neural Computation) that covers much of the material in this course

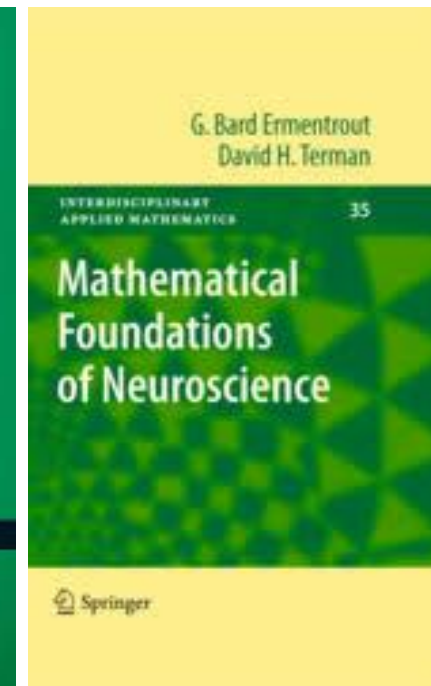
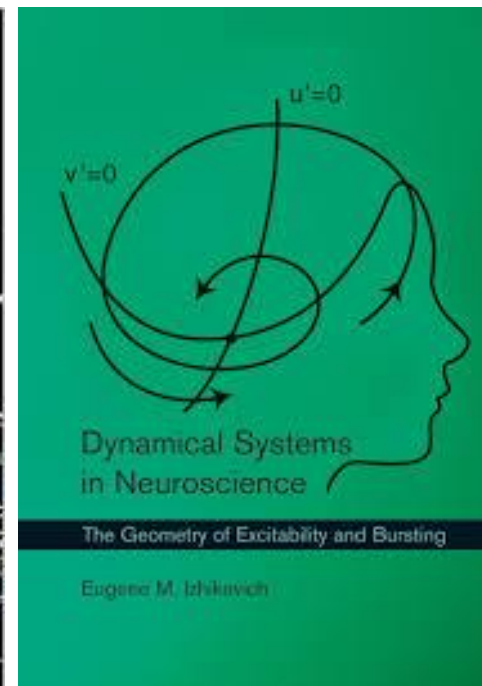
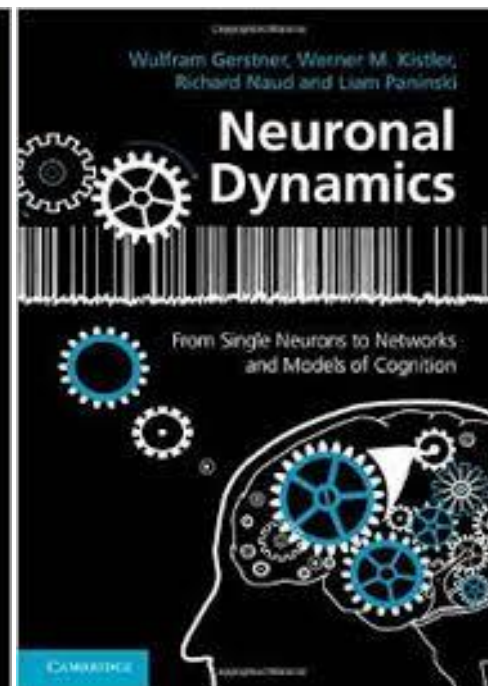
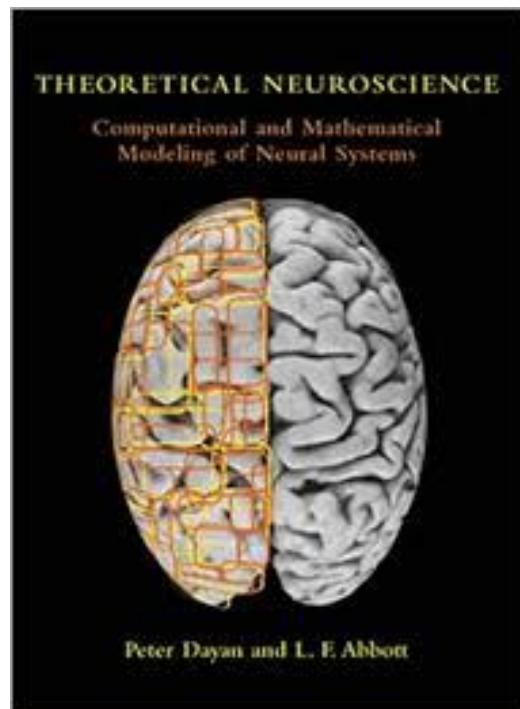

# Overview of Upcoming Lectures

---

**Lecture 2:** Overview of (computational) neuroscience

**Lectures 3-5:** Biophysics of single neurons

**Lecture 6:** Neural spike statistics

**Lecture 7:** The visual system

**Lectures 8-10:** Neural coding

**Lectures 11-12:** Networks

**Lectures 13-15:** Plasticity, learning and memory

**Lab only (final lab):** Neural data analysis

# Questions

---

